

# Instruction Manual for DU08 /DU09 Operation Panel

## 1. Ordering Code

Description on the ordering code:

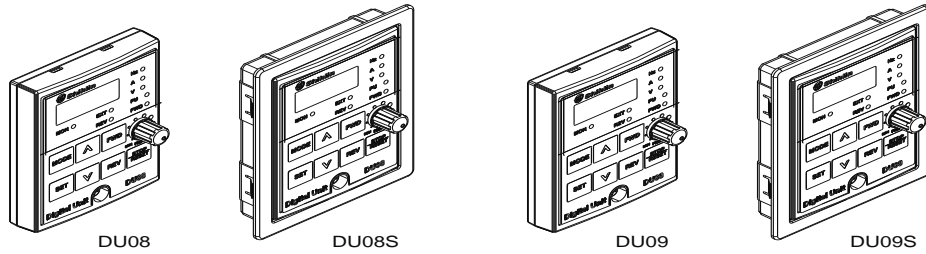

NO.	Model	Item Name	Ordering Code
1	DU08	DU08 operation	SNKDU08
2	DU08S	DU08S operation	SNKDU08S
3	DU09	DU09 operation	SNKDU09
4	DU09S	DU09S operation	SNKDU09S

Note: DU08, DU08S for SS2 series inverter, DU09, DU09S applicable to SF-G series inverter V0.320 and above version (version identifiers for-02 and above).

## 2. Outline drawing of DU08/DU09

<Outline drawing>

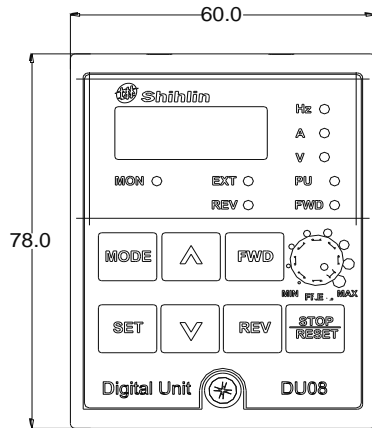

< Surface mounting hole size figure >

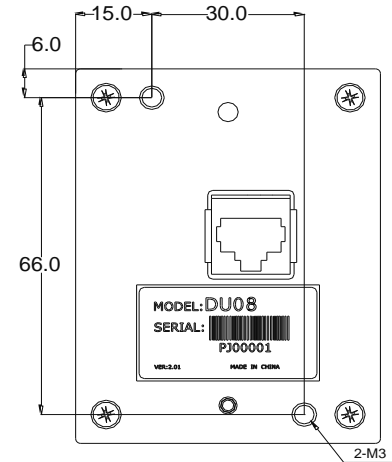
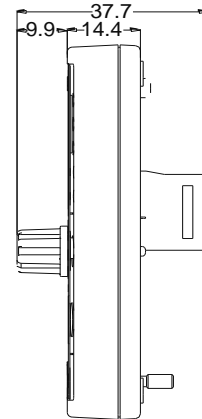

< Flange installation hole size chart (note) >

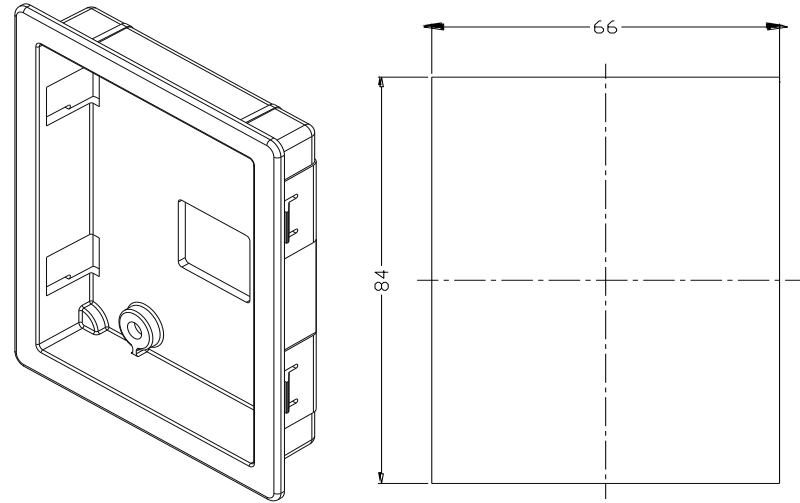
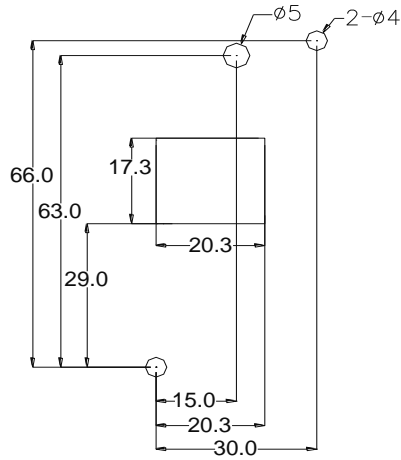

Note: When flange installation, need to purchase another mounting housing, order code: SNKDUMH02 (DU08S、DU09S already includes the installation of the base) .

### 3. CBL: Data transmission line (coordinated with the operation panel)

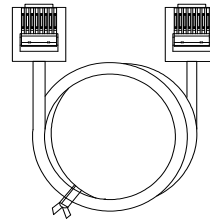

Description on the ordering code:

NO.	Model	Item name	Ordering code
1	CBL1R5GT	Data transmission line (Length: 1.5M)	SNKCBL1R5GT
2	CBL03GT	Data transmission line (Length: 3M)	SNKCBL03GT
3	CBL05GT	Data transmission line (Length: 5M)	SNKCBL05GT

### 4. Primary Operation

#### 4.1 The flow chart for switching the operation mode

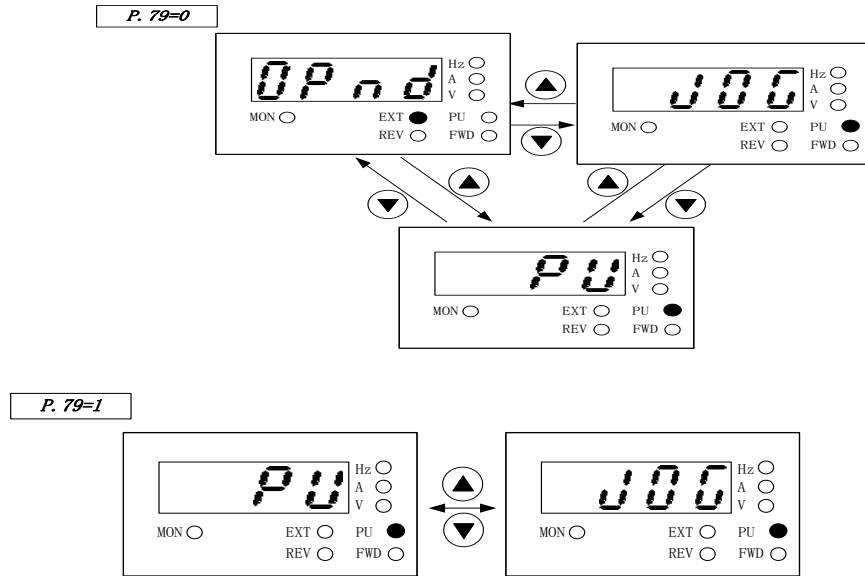

#### 4.2 The flow chart for switching the working mode

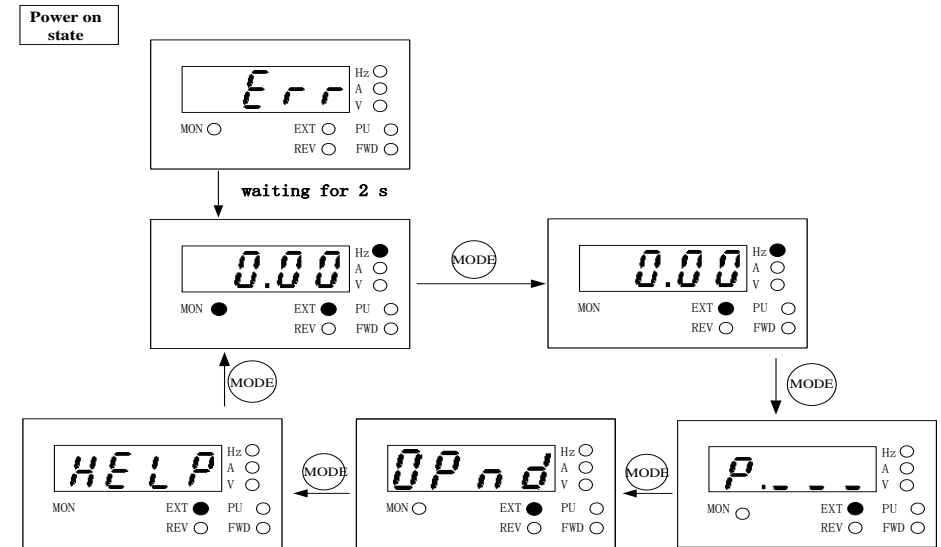

- Note: 1. At the PU mode, the indicating lamp **PU** will be lit up.
2. At the external mode, the display screen will display *OPnd*
3. At the combined mode 1, 2, 3, 4 or 5, the indicating lamp **PU** will flicker.
4. At the JOG mode, the indicating lamp **PU** will be lit up, and at the same time the display screen will display *JOG* while the motor is not running.
5. The operation mode will be constant if P.79 is equal to 2, 3, 4, 5, 6, 7 or 8, so there are no flow charts for it.
6. It needs to press "SET" key to set the operation mode after switching.

- Note: 1. For detailed operating flow at monitoring mode, please refer to Section 4.3.
2. For detailed operating flow at frequency setting mode, please refer to Section 4.4.
3. For detailed operating flow at parameter setting mode, please refer to Section 4.5.
4. For detailed operating flow at **HELP** mode, please refer to Section 4.6.

#### 4.3 The flow chart for monitoring mode

Taking the PU mode for example:

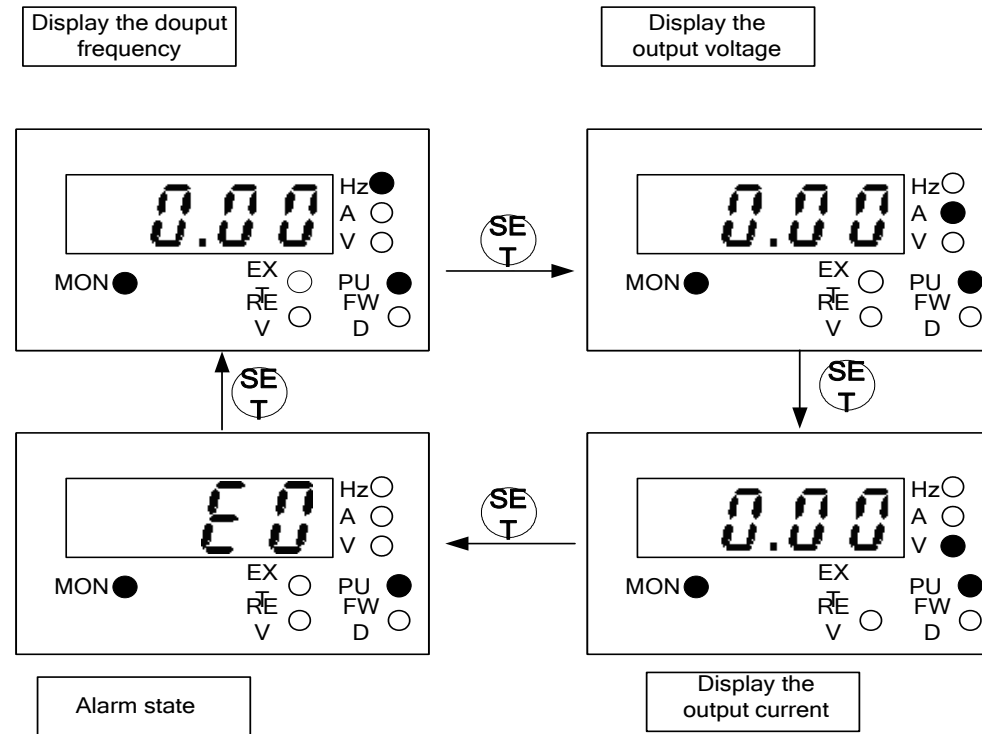

(Note 1)

1. 「monitor the output frequency」, the indicator light **MON** and **Hz** will be lit, and the screen will display the output frequency.
2. 「monitor the output voltage」, the indicator light **MON** and **V** will be lit, and the screen will display the output voltage.
3. 「monitor the output current」, the indicator light **MON**, **Hz** and **V** will be lit, and the screen will display the output current.
4. 「browse the alarm information」, the indicator light **MON** will be lit, and the screen will display the alarm code.

(Note 2) Please refer to the instruction manual of each series Shihlin inverter for the alarm code.

#### 4.4 The flow chart for frequency setting mode

#### 4.5 The flow chart for parameter setting mode

Taking the PU mode for example:

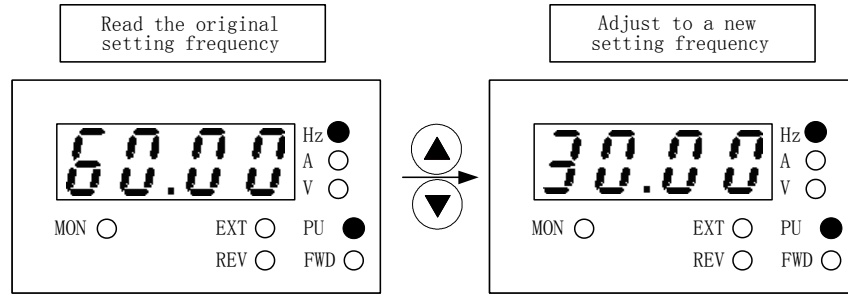

注: 1. Modify the frequency with ▲▼ when the inverter is running.  
 2. In the mode of setting frequency, the indicator light **Hz** and **PU** will be lit, and the indicator light **MON** will not be lit.  
 3. The setting frequency should not be larger than the upper limit frequency, and the upper limit frequency should be modified firstly when the high frequency running is needed.

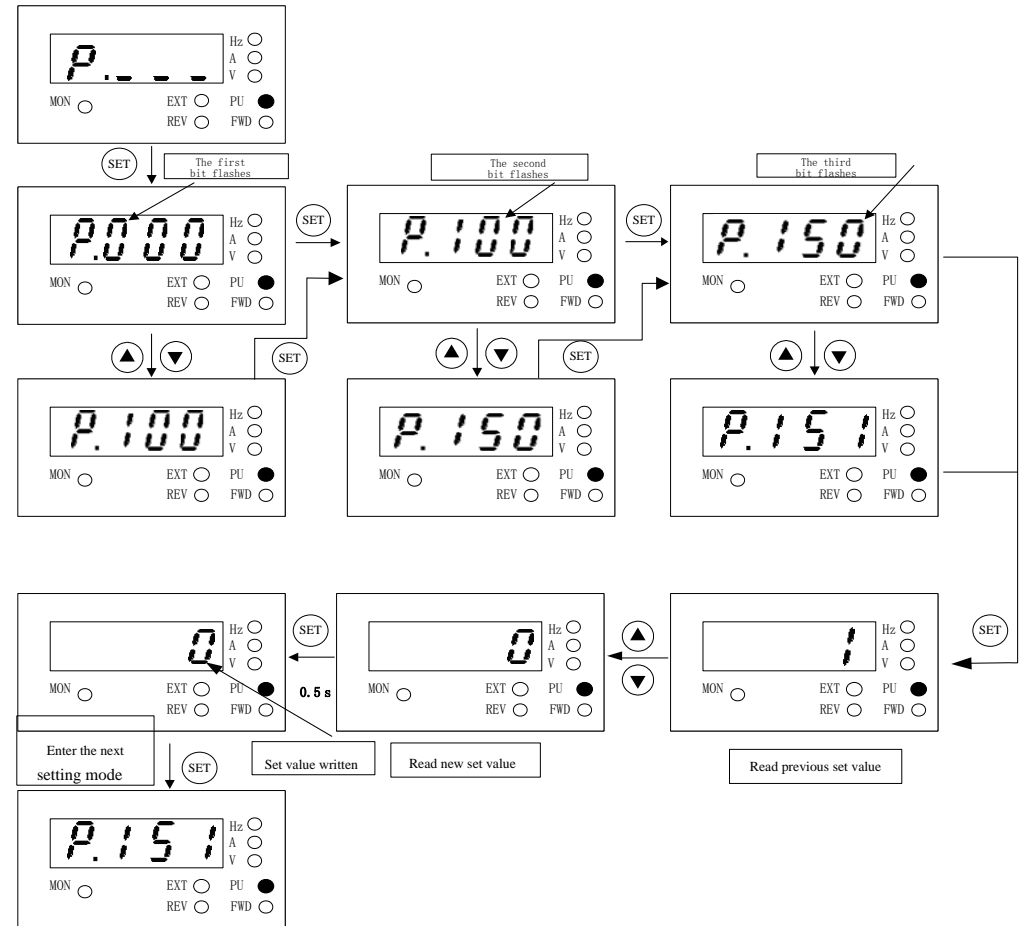





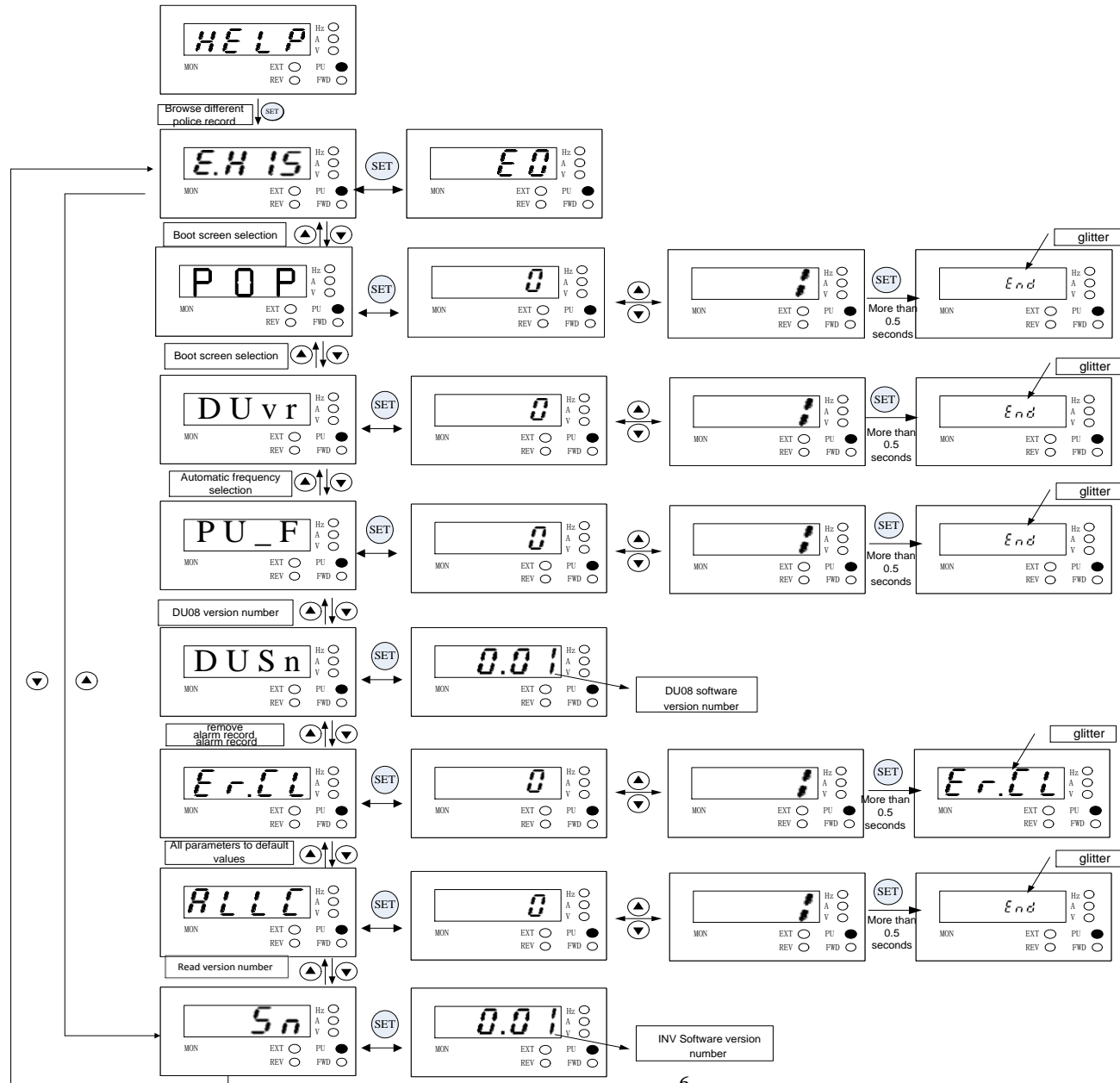

Note: At the parameter setting mode, both the indicating lamp of **Hz** and **MON** will be off. Please make sure to hold down the **SET** key for more than 0.5s when writing for the set value of the parameters.

#### 4.6 The flow chart for HELP mode







#### 4.7 Parameter Copy Function (Pr.CP, Pr.CA)

##### Pr.CP “Parameter copy readout” Pr.CA “Parameter copy write-in”





- Parameter copy function is valid only when the motor is stop, P.77=0, and under the PU mode. If several inverters need set same parameter values, just only set one inverter parameters, then use Pr.CP and Pr.CA to quickly copy the values to other inverters.
- Parameter copy operation procedure:
  1. When the first inverter is in the PU mode, press  to switch to the parameter setting mode. Rotate  until *Pr.CP* is displayed, and it will display “0” after pressing . Then rotate  to change the value to “1” and write in by pressing . The screen will display the parameter number one by one, which indicates that the parameters are copied from the inverter to the operation panel. When the parameter copying is completed the screen will display *End* and flickering.
  2. When the second inverter is in the PU mode, after *Pr.CA* is read out, the screen of the panel will display the initial value “0”. Rotate  to change the value to “1” and write in by pressing . The screen will display the parameter number one by one, which indicates that the parameters are copied from the operation panel to the inverter. When the parameter copying is completed, the screen will display *End* and flickering.

Note: 1. If the version of the inverter is updated, pick inverter parameters of the lower version inverter among inverters of different versions for parameter copying.  
2. Parameters cannot be copied between inverters of different series.  
3. When parameters cannot be copied, DU08/DU09 operation panel will display the alarm code “Err”. These alarm codes are not the abnormal alarm codes. When these alarm codes are displayed, inverter reset is not required.







#### 4.8 Alarm History Clear (Er.CL)

- The method: Press to switch to the parameter setting mode, and then press  until “P.996” is displayed, After pressing , *Er.CL* will be displayed, To press SET, “0” is displayed. After that, Press  to change the value to 1 and press  to write in. At last, all the alarm history will be cleared.

#### 4.9 Inverter Reset (rEST)

- The method: Press  to switch to the parameter setting mode, and then press  until “P.996” is displayed, After pressing , *Er.CL* will be displayed, To set SET, “0” is displayed. Press  to change the value to “1”, and press  to write in that the inverter will be reset. After that, the thermal accumulation value of the electronic thermal relay capacity and the electronic thermal relay of the inverter’s IGBT module will return to zero.

#### 4.10 Restoring all parameters to default values (ALLC) Restoring some parameters to default values (PrCr)

- The method for the function of restoring all parameters to default values: Press  to switch to the parameter setting mode, press  until “P.998” is displayed, press , *ALLC* will be displayed, Press once again , “0” is displayed. Press  to change the value to “1” and press  to write in that all the parameters except P.21、 P.188、 P.189、 P.190~P.199、 P.292、 P.293、 P.300~P.309 will be restored to the factory setting value.
- The method for the function of restoring some parameters to default values: Press to switch to the parameter setting mode, press until “P.998” is displayed, press , will be displayed, Press once again, “0” is displayed. Press to change the value to “1” and press to write in that all the parameters except P.21、P.188、P.189、P.190~P.199、

P.292、P.293、P.300~P.309 will be restored to the factory setting value.

- When the operation of restoring all or some parameters to default values is carried out, please make sure that other operations are done after **End** is displayed on the screen which means that the parameters have restored to default values.

#### 4.11 Automatic writing frequency function selection (PU\_F)

- After DU08/DU09 automatic writing frequency function is selected, target frequency can be changed by  $\uparrow \downarrow$  when inverter is in target frequency mode (such as PU mode, combined mode 1) given by operation panel and DU06 is in monitoring mode or target frequency setting mode. And the target frequency changed will be written into inverter immediately without action of pressing **SET** key.
- The method: Press **MODE** to switch to **HELP** mode, press **SET** and then press  $\uparrow \downarrow$  until "PU\_F" is displayed. After pressing **SET**, value will be displayed, and you can press  $\uparrow \downarrow$  to change value in the range of 0~2. Rotate to value which is changed to, then press **SET** to write in as long as the **End** flickers which means written is finished.
- The meaning of setting value of "PU\_F" is as follows:
  - "0": has not automatic writing frequency function. To write the target frequency of DU08/ DU09 panel into inverter, you must press **SET** to write in.
  - "1": has automatic writing frequency function. When the power is off, the target frequency's save period is 10 seconds.
  - "2": has automatic writing frequency function. When the power is off, the target frequency's save period is 30 seconds.

#### 4.12 Setting Dial Function Selection (DUvr)

- Knob frequency setting function selection after setting, the panels set target frequency mode, the target frequency determined by DU08 / DU09 knob.
- The method: Press **MODE** to switch to **HELP** mode, press **SET** and then press  $\uparrow \downarrow$  until "DUvr" is displayed. After pressing **SET**, the value will be displayed, and you can press  $\uparrow \downarrow$  to change the value in the range of 0~1. then press **SET** to write in as long as the **End** flickers which means the written is finished.
- The meaning of "DUvr" setting value is as follows:
  - "0": The target frequency knob Settings.
  - "1": The target frequency set by the knob.

#### 4.13 Boot Screen Selection (POP)

- When DU08/DU09 is powered on, the display screen is set by POP.
- Usage: Press to switch to mode, press to display "POP" through adjustment. Press, the value will be displayed, and the value can be modified in the range of 0~3 through adjustment. Adjust to the value to be modified, long press write, write success will be displayed flashing.
- The meaning of the set value of "POP" is as follows:
  - 0: The boot screen is the output frequency file of the monitoring mode.
  - 1: The boot screen sets the target frequency setting mode.
  - 2: The boot screen is the output current file of the monitoring mode.
  - 3: The starting screen is the output voltage of the monitoring mode.

To improve our products, the parameters and contents may be modified, please contact the agent or refer to Shihlin websites(<http://automation.seec.com.tw/>) to download the latest version



Version: V1.01

Production time: May 2020